

BRAIN CELL

Here's what we used...

SCENEARAMA® Items

- Sculpting Kit
- Plaster Cloth
- Small Project Base & Backdrop

Household Items

- Corrugated Cardboard, 10" x 10"
- Cutting Surface
- Disposable Cup
- Foam Core Board, 8" x 10"
- Masking Tape
- Pan for Water
- Plastic Wrap
- Rolling Pin
- Scissors
- Wax Paper

Did you know?

One of the most common cells in the brain are neurons. Neurons are the cells that store and process information. Information is transmitted through electrochemical signals between the brain and nervous system. Neurons communicate with each other through a process called synapsis. There are approximately 100 billion neurons in the brain.

Fun Fact!

The average number of neurons in an octopus brain is about 300 million.

1



- Sketch a Neuron on a piece of cardboard.
- Cover cardboard with plastic wrap and tape to hold.

TIP! Research cells, then print a picture to use as a reference.

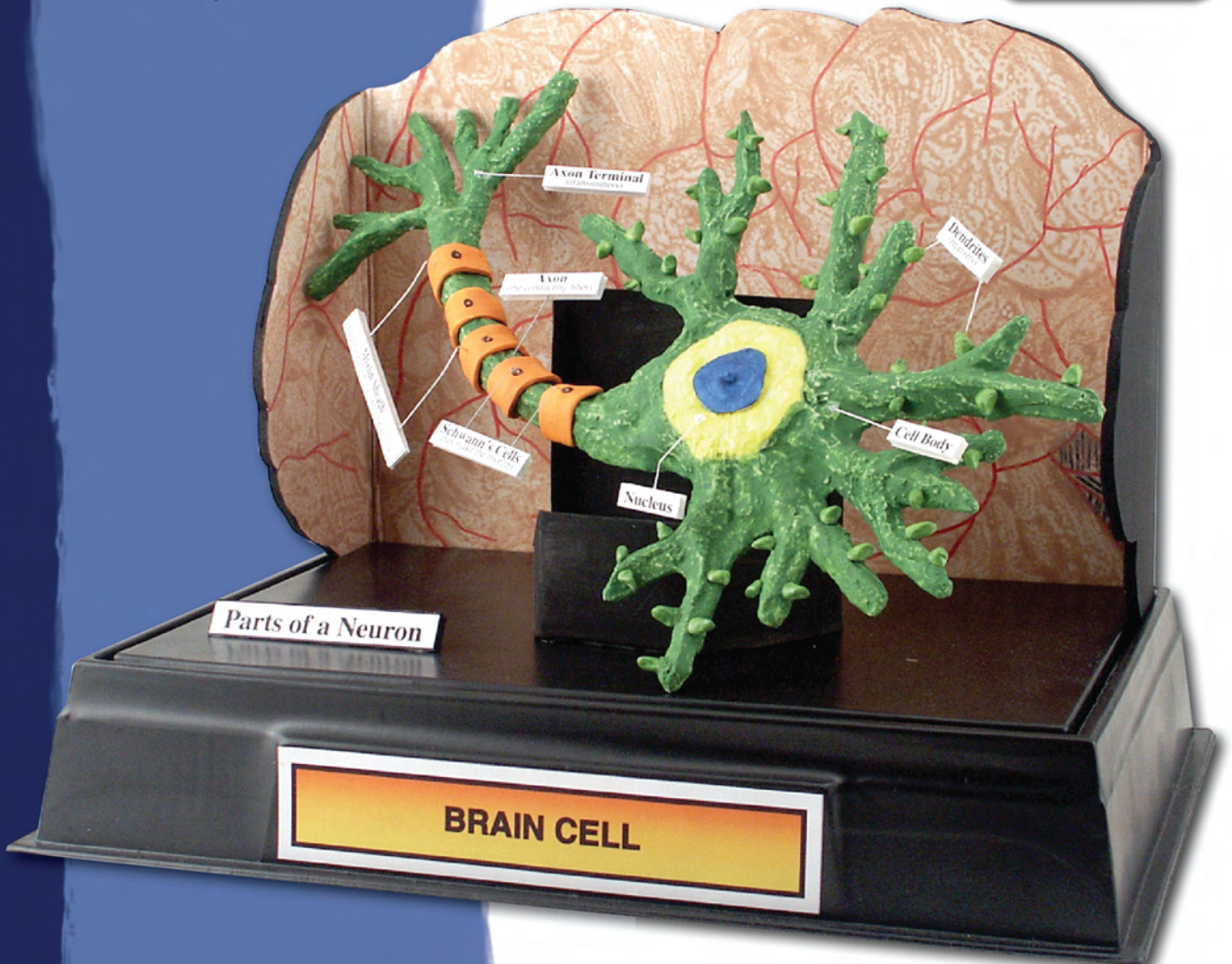

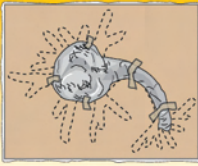
2

i Newspaper Wads

- Using your drawing as a guide, wad a half sheet of newspaper to create center cell body (Soma) shape.
- Wad another half sheet of newspaper to create the elongated (Axon) shape.
- Use masking tape to attach the two pieces together.

3

i Plaster Cloth

- Cover the entire cell shape with wet *Plaster Cloth* (3" strips), bumpy side up.
- Apply 2 layers of *Cloth*.

4

Fig. 4a

- Form Axon Terminals with pinched and formed strips of wet *Plaster Cloth*.
- Brush water on area of cell body before placing each wet strip of *Plaster Cloth*. (Fig. 4a)
- Pinch and mold wet *Plaster Cloth* for desired shape. Hold strip in place on cell until setting begins.

5

- Continue placing strips as in Step 4 until satisfied with look of cell.
- Let dry.

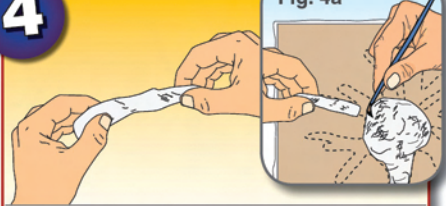
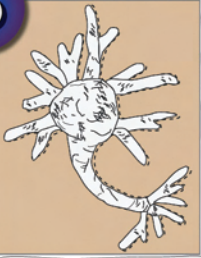
6

i Sculpt

- Pinch off small pieces of *Sculpting Clay* and form into Dendrite shapes.
- Use *Project Glue* to attach to Axon Terminals around cell body.

7

- Flatten a small amount *Clay* with rolling pin (approx. 1/16" thick) on a sheet of wax paper. Cut *Clay* into rectangular slices to create Myelin Sheath.
 - Wrap around Axon and pinch together.
 - Add a drop of *Project Glue*, if desired.
- NOTE:** Be sure to leave space between clay Myelin Sheaths to account for Nodes of Ranvier.

8

- Flatten clay in a circle to create Nucleus.
- Cut a small circle.
- Attach to cell body with *Project Glue*.
- Let dry.

9

i Paint

- Using *Project Paints*, paint cell as desired.

10

i Project Base & Backdrop

- Design a *Backdrop* that best fits your cell.
- Cut out with a hobby knife.
- Paint *Backdrop* as desired.

11

i Easel Templates and Contact Gluing Method

- Design an easel using foam core board.
- Cut out with a hobby knife.
- Using the Contact Gluing Method, attach easel to *Project Base*.
- Let dry.
- Make sure label area on *Project Base* faces forward.

12

i Labels

- Glue *Backdrop* to *Project Base*.
- Glue cell to easel.
- Label and add signage to your project.

i See the *A+ PROJECTS & DIORAMAS: The Student's Handbook (SP4171)* for more information.

More Ideas!

Use newspaper wads to form the basic shape, then cover in Plaster Cloth to create this Splitting Cell project. The organelles and parent cell were made using Sculpting Clay and Project Paints from the Sculpting Kit.



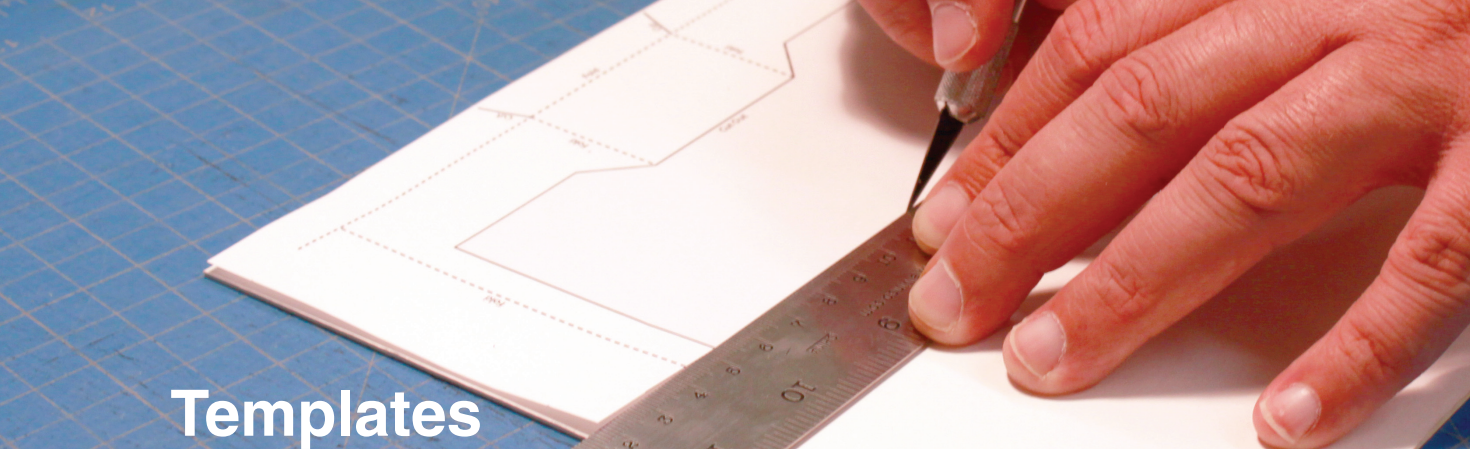

Templates

- Photocopy, trace or scan template onto white paper. Cut out, then trace onto specified material.
- If needed, reduce or enlarge templates to fit your diorama.
- Each template includes basic assembly instructions and needed materials.
- Read through the corresponding project instructions for clarification on using template.
- Short dotted lines ----- indicate fold lines
- Long dotted lines — — — indicate score lines
- Bold, solid lines ——— indicate cut lines

Easel 1

Egyptian Burial Mask, Medusa, Bacteria Cell, Brain Cell, Lungs and Smoking

- Copy template or trace on white paper.
- Cut out copied template and trace on foam core board, 1/8".
- Cut out with a hobby knife.
- Assemble with Project Glue.
- If using cardstock, make size adjustments.

Tip!

Choose the size stand that best fits your project. (a=smallest, d=largest)

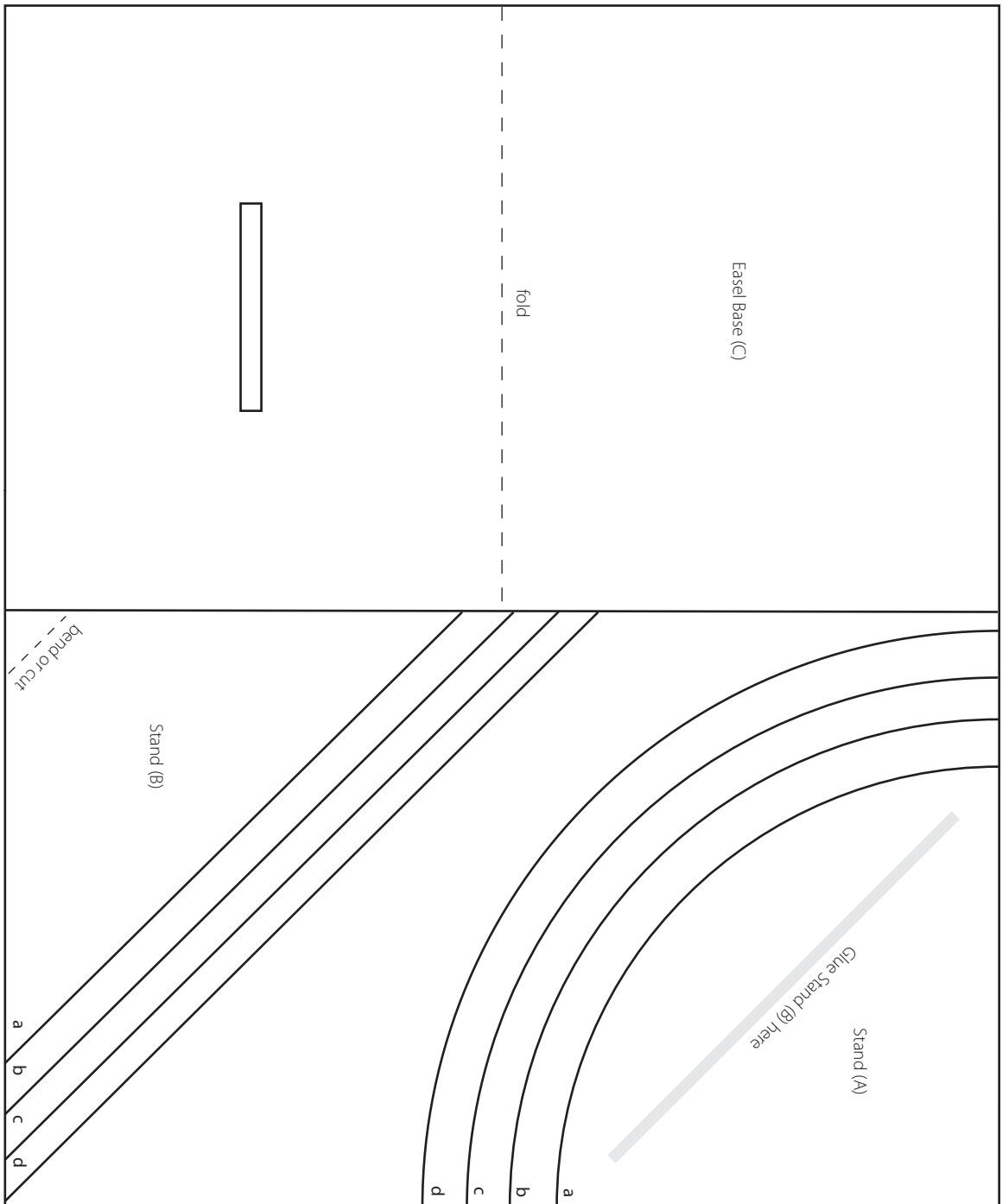
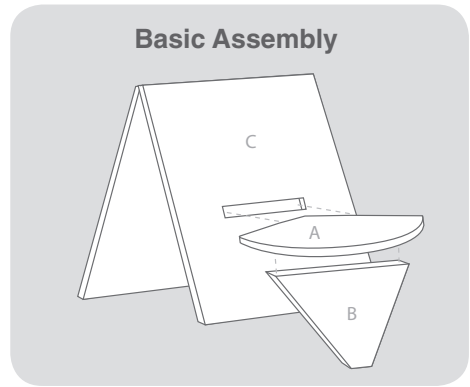

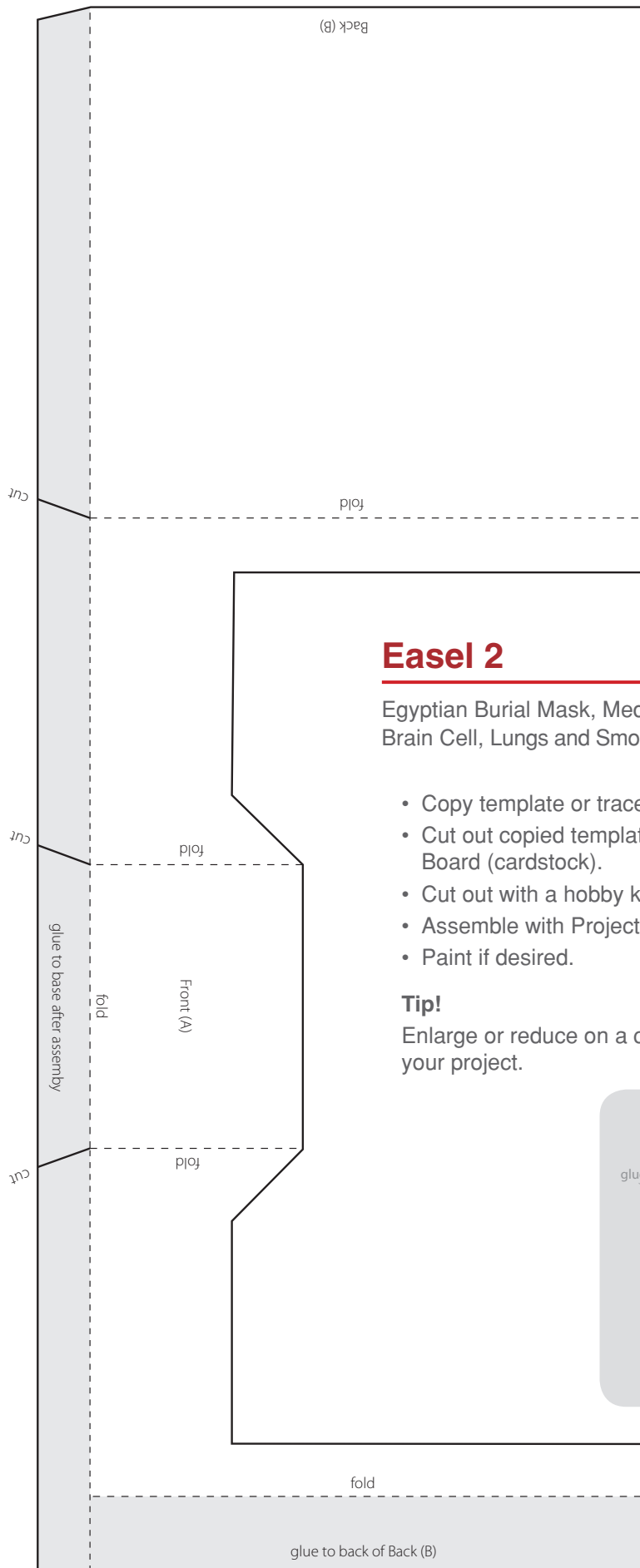

Easel 2

Egyptian Burial Mask, Medusa, Bacteria Cell, Brain Cell, Lungs and Smoking

- Copy template or trace on white paper.
- Cut out copied template and trace on Construction Board (cardstock).
- Cut out with a hobby knife.
- Assemble with Project Glue.
- Paint if desired.

Tip!

Enlarge or reduce on a copier to a size that best fits your project.

